

M-SERIES

INPUT: 120VAC

Specification Sheet

Constant Voltage Magnetic Phase-Dimmable 12/24VDC LED Driver

The M-SERIES is the most compact magnetic core dimmable LED driver on the market, making it the perfect choice for tape lighting, tube lighting, linear lighting and multiple other residential and commercial lighting applications. Encased in a high-quality metal enclosure that includes multiple 7/8" knockouts for easy installation, each unit is equipped with circuit breakers to protect both the driver and the LED load. All of our magnetic LED drivers are phase-dimmable with a standard leading-edge MLV TRIAC dimmer.



100W/150W/200W
 9.80" x 3.00" x 2.74"
300W
 9.80" x 4.20" x 3.50"

20/40W
 5.60" x 2.10" x 2.10"
50W/60W/96W
 6.62" x 2.33" x 2.58"



CLASS 2 | 120VAC | 12 / 24VDC

- Installation:** Integrated Junction Box with Multiple 7/8" Knockouts
- Driver Types:** Class 2 and Higher Power Single Channel Options
- Dimming:** Phase Dimmable with Leading (Forward) Edge MLV TRIAC Dimmer Only
- Input Voltage:** 120VAC, 50/60Hz
- Output Voltage:** 12VDC or 24VDC
- Environmental:** NEMA 3R
- Listing:** ETL Listed
- Certifications:** Conforms to UL8750, C22.2 NO. 223
- Warranty:** 5-Year Warranty

M-SERIES is also available in:
 M-SERIES 277VAC
 Refer to Magnitudeinc.com for more details.

ORDERING GUIDES - AUTO & MANUAL RESET BREAKERS

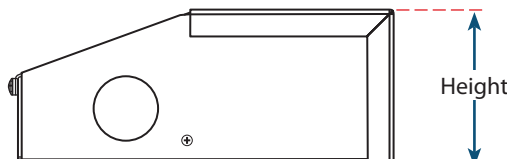
AUTO RESET BREAKERS					MANUAL RESET BREAKERS			
Type	Max Power	Listing	Output	Safety	Type	Max Power	Listing	Output
M – Magnetic	20 ¹	L – ETL Listed	12DC – 12VDC	AR – Auto Reset	M – Magnetic	200 – 200W	L – ETL Listed	12 – 12VDC
	40 ¹					300 – 300W		
	50 ^{1,3}							
	60 ¹							
	96 ^{1,2}							
	100 ³							
	150							
¹ Class 2 ² 24VDC only ³ 12VDC only								

DRIVER MEASUREMENTS

Dimensions	20 / 40W	50W / 60W / 96W	100W / 150W / 200W	300W
Length	5.60" (142.2mm)	6.62" (168.15mm)	9.80" (248.9mm)	10.07" (255.78mm)
Width	2.00" (50.8mm)	2.58" (65.53mm)	3.00" (76.2mm)	4.20" (106.7mm)
Height	2.14" (54.36mm)	2.33" (59.18mm)	2.74" (69.6mm)	3.50" (88.9mm)

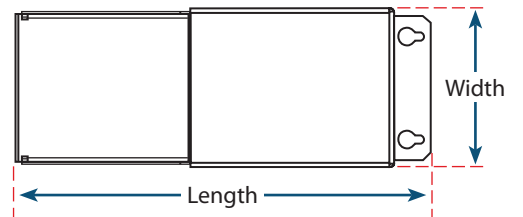

SPECIFICATIONS

Average voltage measurement required.
 Must be measured with Oscilloscope, Multimeters will give inaccurate voltage readings.

INPUT	20W	40W	50W	60W	96W
Input Voltage Range	120VAC ± 5%	120VAC ± 5%	120VAC ± 5%	120VAC ± 5%	120VAC ± 5%
Input Frequency	50/60Hz	50/60Hz	50/60Hz	50/60Hz	50/60Hz
Input Current	0.21A (12VDC) 0.19A (24VDC)	0.43A (12VDC) 0.38A (24VDC)	0.52A (12VDC) ---	0.64A (12VDC) 0.55A (24VDC)	--- 0.97A (24VDC)
Efficiency	69.73% (12VDC) 73% (24VDC)	73.21 % (12VDC) 77% (24VDC)	73.5 % (12VDC) ---	74% (12VDC) 80% (24VDC)	--- 77% (24VDC)
Power Factor	0.92 (12VDC) 0.93 (24VDC)	0.96 (12VDC) 0.93 (24VDC)	0.96 (12VDC) ---	0.96 (12VDC) 0.93 (24VDC)	--- 0.98 (24VDC)

OUTPUT	20W	40W	50W	60W	96W
Max Load	20W	40W	50W	60W	96W
Output Voltage @ Max Load	11.44 (12VDC) 22.60 (24VDC)	11.56 (12VDC) 22.90 (24VDC)	11.55 (12VDC) ---	11.55 (12VDC) 22.40 (24VDC)	--- 23.20 (24VDC)
Output Current @ Max Load	1.40A (12VDC) 0.70A (24VDC)	3.10A (12VDC) 1.40A (24VDC)	4.33A (12VDC) ---	4.70A (12VDC) 2.20A (24VDC)	--- 3.80A (24VDC)
Open Circuit Output Voltage	12.4VDC 24.4VDC	12.8VDC 25.7VDC	12.6VDC ---	12.5VDC 25.0VDC	25.8VDC ---

ENVIRONMENTAL	20W	40W	50W	60W	96W
Operating Temperature	-30°C to +45°C (-22°F to 113°F)	-30°C to +45°C (-22°F to 113°F)	-30°C to +45°C (-22°F to 113°F)	-30°C to +45°C (-22°F to 113°F)	-30°C to +45°C (-22°F to 113°F)
Min. Installation Spacing	5"	5"	5"	5"	5"
Thermal Class	B130°C	B130°C	B130°C	B130°C	B130°C

DIMMING	20W	40W	50W	60W	96W
Min. Dimming Level	1%	1%	1%	1%	1%

PROTECTION	20W	40W	50W	60W	96W
Circuit Breaker	Primary & Secondary Auto Reset	Primary & Secondary Auto Reset	Primary & Secondary Auto Reset	Primary & Secondary Auto Reset	Primary & Secondary Auto Reset

MECHANICAL HOUSING	20W	40W	50W	60W	96W
Primary Leads	18AWG	18AWG	18AWG	18AWG	18AWG
Secondary Leads	16AWG (12VDC) 18AWG (24VDC)	16AWG (12VDC) 18AWG (24VDC)	14AWG (12VDC) ---	14AWG (12VDC) 16AWG (24VDC)	14AWG (12VDC) ---
Length	5.60" (142.2mm)	5.60" (142.2mm)	6.55" (166.37mm)	6.55" (166.37mm)	6.55" (166.37mm)
Width	2.00" (50.8mm)	2.00" (50.8mm)	2.55" (64.77mm)	2.55" (64.77mm)	2.55" (64.77mm)
Height	2.14" (54.36mm)	2.14" (54.36mm)	2.55" (64.77mm)	2.55" (64.77mm)	2.55" (64.77mm)
Weight	2.2 lbs.	2.2 lbs.	3.1 lbs.	3.1 lbs.	3.5 lbs.
Housing Material	Coated Metal	Coated Metal	Coated Metal	Coated Metal	Coated Metal
Housing Color	Black	Black	Black	Black	Black
Junction Box	Yes	Yes	Yes	Yes	Yes
Mounting	2-hole flange mount	2-hole flange mount	2-hole flange mount	2-hole flange mount	2-hole flange mount

APPROVAL MARKINGS	20W	40W	50W	60W	96W
Certificates and/or Approval Signs	ETL Listed Conforms to UL 8750	ETL Listed Conforms to UL 8750	ETL Listed Conforms to UL 8750	ETL Listed Conforms to UL 8750	ETL Listed Conforms to UL 8750

SPECIFICATIONS

Average voltage measurement required.
 Must be measured with Oscilloscope, Multimeters will give inaccurate voltage readings.

INPUT	100W	150W	200W	300W
Input Voltage Range	120VAC ± 5%	120VAC ± 5%	120VAC ± 5%	120VAC ± 5%
Input Frequency	50/60Hz	50/60Hz	50/60Hz	50/60Hz
Input Current	1.01A (12VDC) ---	1.38A (12VDC) 1.28A (24VDC)	1.84A (12VDC) 1.80A (24VDC)	2.20A (12VDC) 2.87A (24VDC)
Efficiency	77% (12VDC) ---	82% (12VDC) 82% (24VDC)	88% (12VDC) 83% (24VDC)	96% (12VDC) 87% (24VDC)
Power Factor	0.96 (12VDC) ---	0.96 (12VDC) 0.98 (24VDC)	0.93 (12VDC) 0.98 (24VDC)	0.88 (12VDC) ---

OUTPUT	100W	150W	200W	300W
Max Load	100W	150W	200W	300W
Output Voltage @ Max Load	11.73 (12VDC) ---	11.69 (12VDC) 22.00 (24VDC)	11.80 (12VDC) 23.30 (24VDC)	11.93 (12VDC) 23.50 (24VDC)
Output Current @ Max Load	7.70A (12VDC) ---	11.00A (12VDC) 5.60A (24VDC)	15.00A (12VDC) 7.70A (24VDC)	19.00A (12VDC) 12.32A (24VDC)
Open Circuit Output Voltage	---	13.3VDC 25.6VDC	12.9VDC 26.2VDC	12.4VDC 25.5VDC

ENVIRONMENTAL	100W	150W	200W	300W
Operating Temperature	-30°C to +45°C (-22°F to 113°F)	-30°C to +45°C (-22°F to 113°F)	-30°C to +45°C (-22°F to 113°F)	-30°C to +45°C (-22°F to 113°F)
Min. Installation Spacing	5"	5"	5"	5"
Thermal Class	B130°C	B130°C	B130°C	B130°C

DIMMING	100W	150W	200W	300W
Min. Dimming Level	1%	1%	1%	1%

PROTECTION	100W	150W	200W	300W
Circuit Breaker	Primary & Secondary Auto Reset	Primary & Secondary Auto Reset	Primary & Secondary Manual Reset	Primary & Secondary Manual Reset

MECHANICAL HOUSING	100W	150W	200W	300W
Primary Leads	18AWG	18AWG	18AWG	18AWG
Secondary Leads	12AWG (12VDC) ---	12AWG (12VDC) 14AWG (24VDC)	12AWG (12VDC) ---	12AWG (12VDC) ---
Length	6.62" (168.15mm)	6.62" (168.15mm)	6.62" (168.15mm)	10.07" (255.78mm)
Width	2.58" (65.53mm)	2.58" (65.53mm)	2.58" (65.53mm)	4.20" (106.7mm)
Height	2.33" (59.18mm)	2.33" (59.18mm)	2.33" (59.18mm)	3.50" (88.9mm)
Weight	4.8 lbs.	5.4 lbs.	5.4 lbs.	8.75 lbs.
Housing Material	Coated Metal	Coated Metal	Coated Metal	Coated Metal
Housing Color	Black	Black	Black	Black
Junction Box	Yes	Yes	Yes	Yes
Mounting	2-hole flange mount	2-hole flange mount	2-hole flange mount	2-hole flange mount

APPROVAL MARKINGS	100W	150W	200W	300W
Certificates and/or Approval Signs	ETL Listed Conforms to UL 8750	ETL Listed Conforms to UL 8750	ETL Listed Conforms to UL 8750	ETL Listed Conforms to UL 8750

MECHANICAL DIAGRAMS

20W / 40W

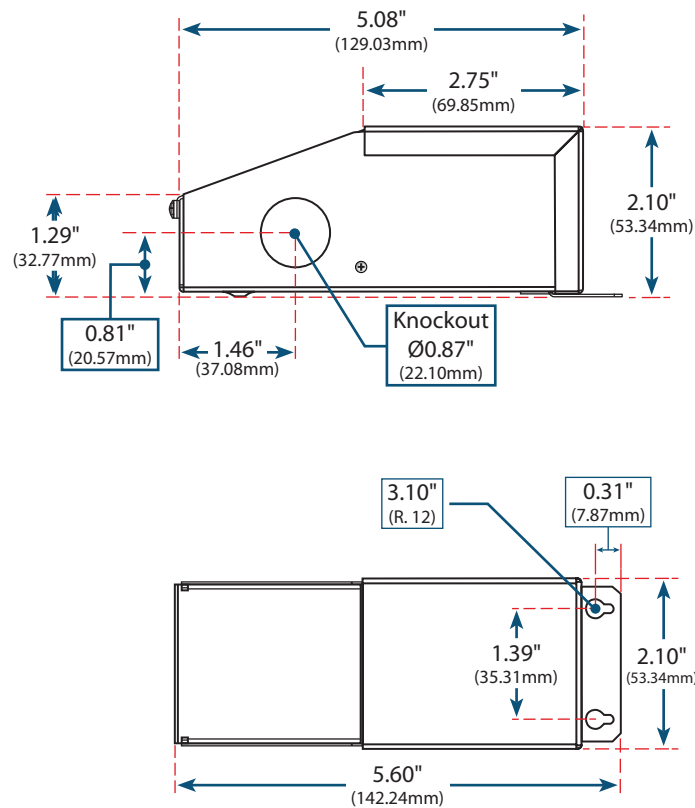

50W / 60W / 96W

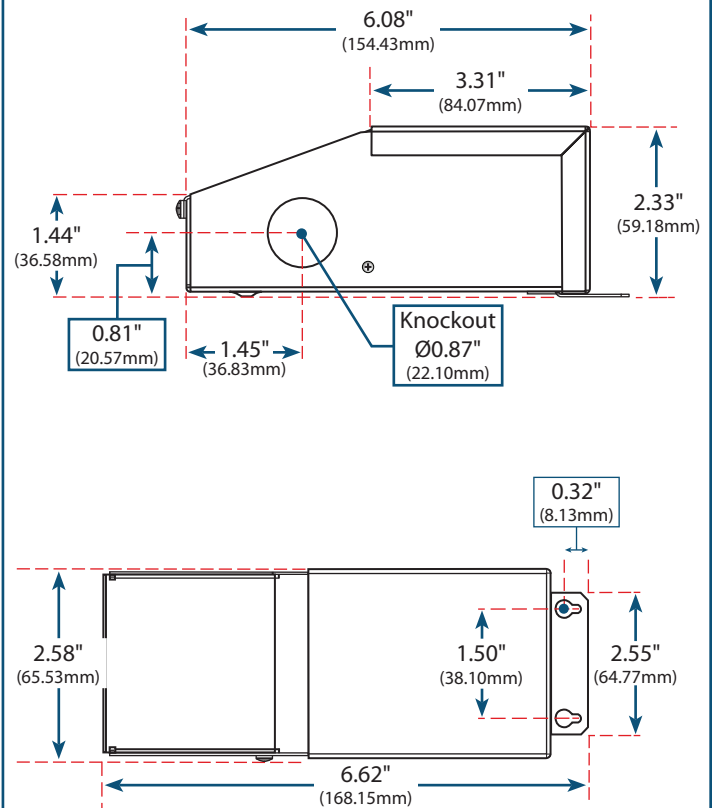

MECHANICAL DIAGRAMS

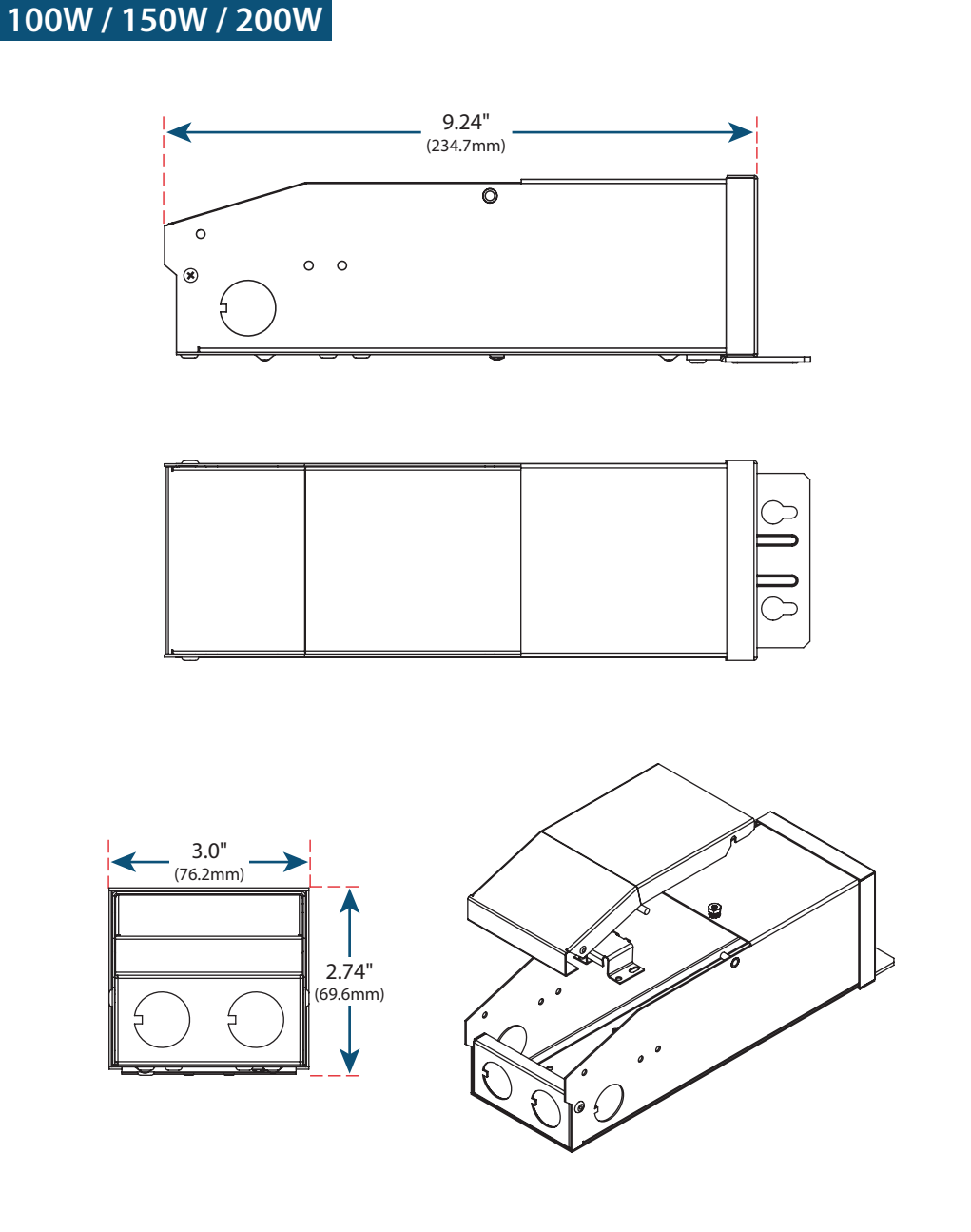

MECHANICAL DIAGRAMS

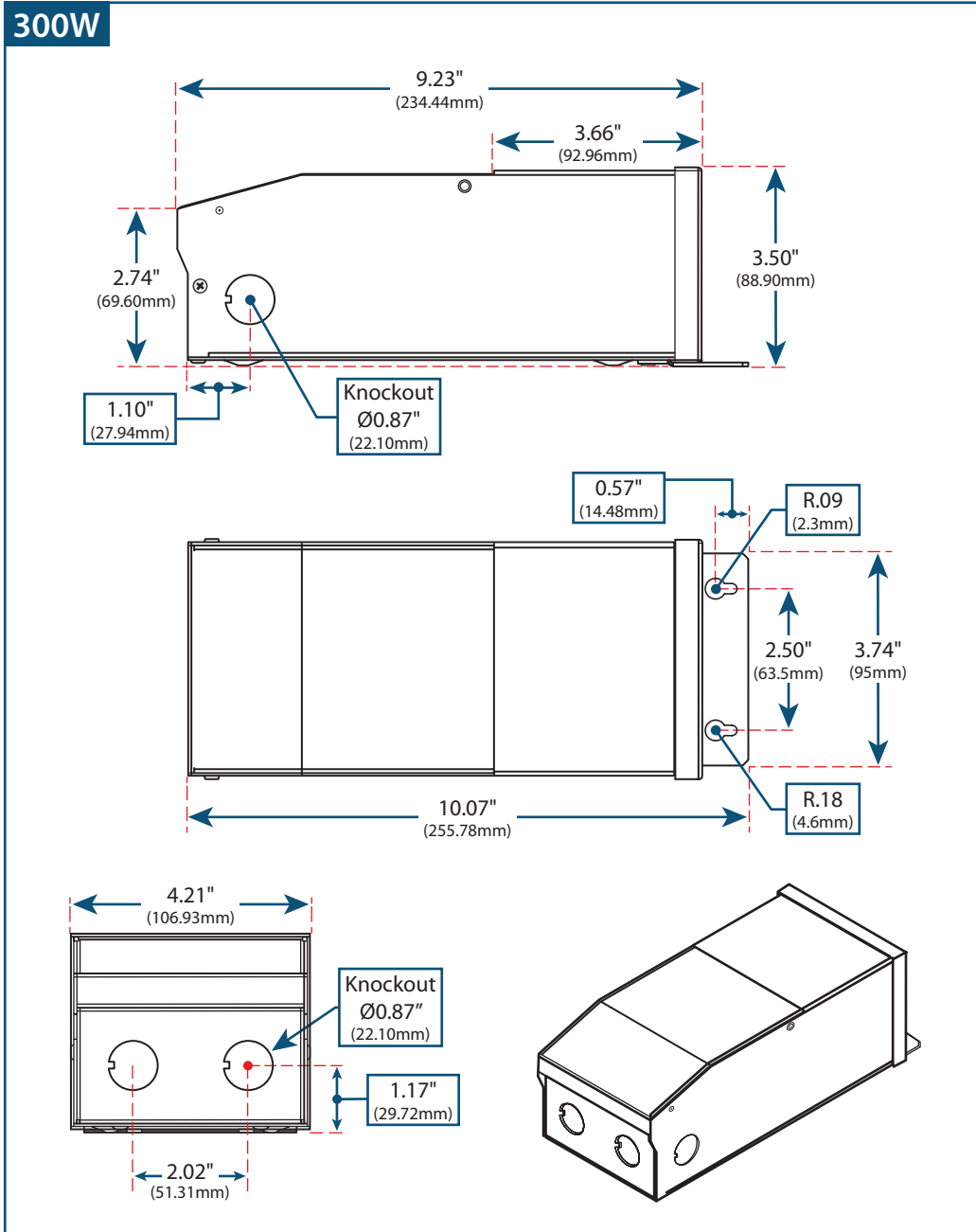

OUTPUT vs LOAD

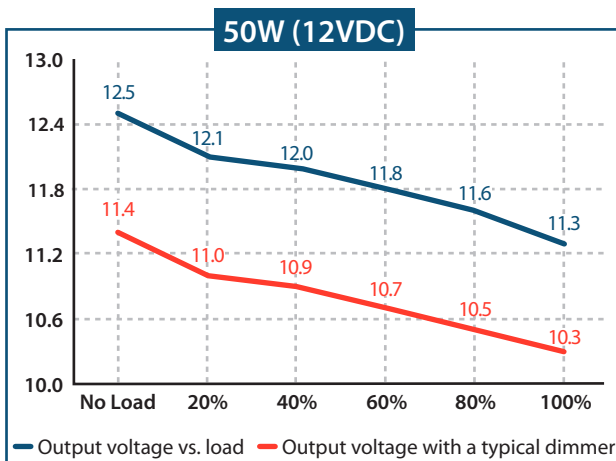
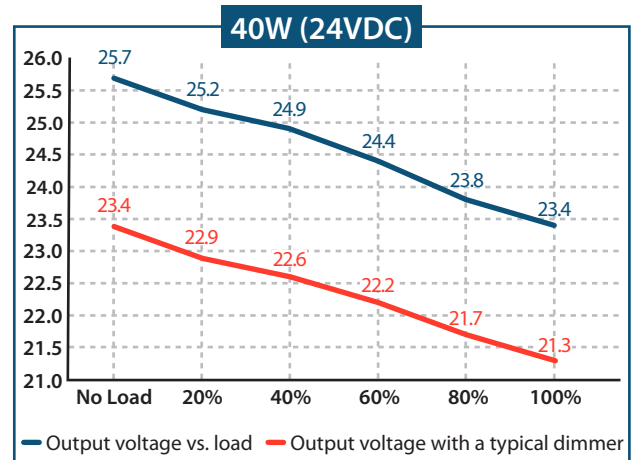
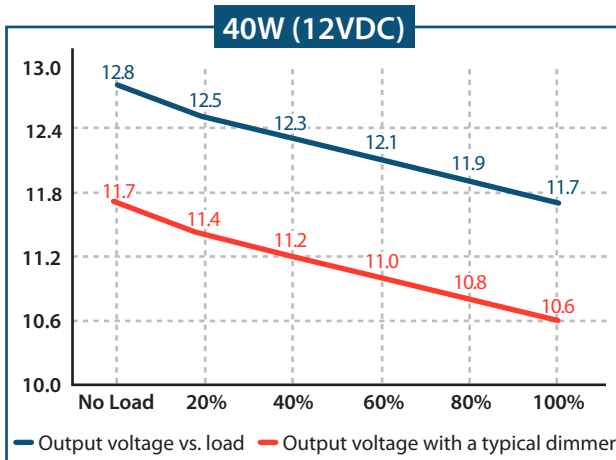
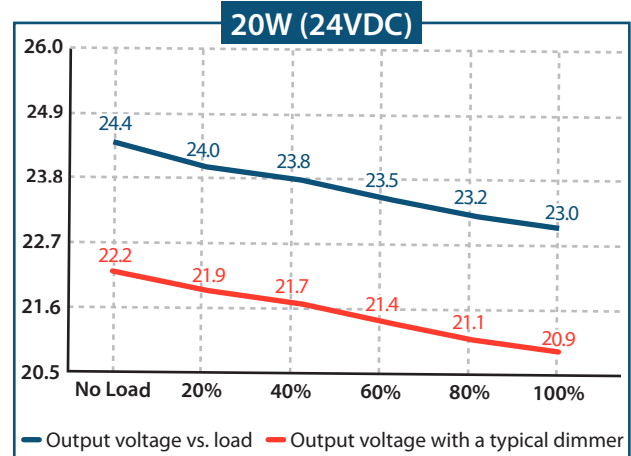
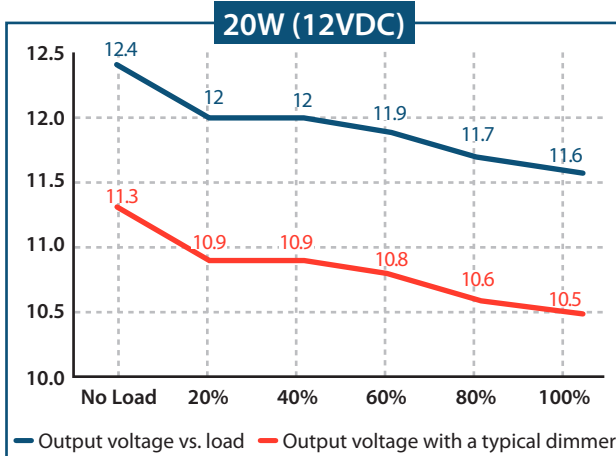

50W (24VDC)

50W 24VDC is not available in the M-Series.

OUTPUT vs LOAD

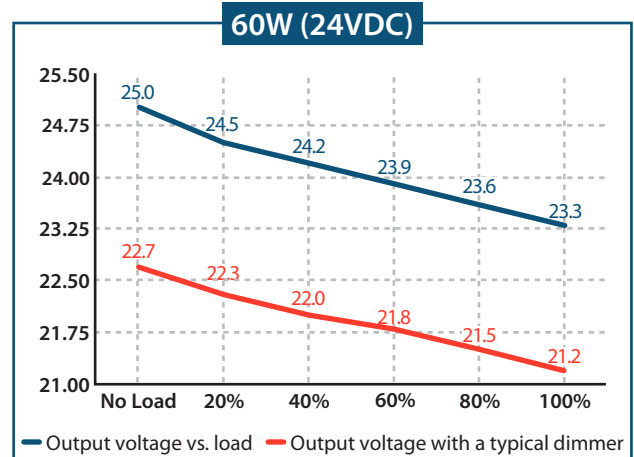
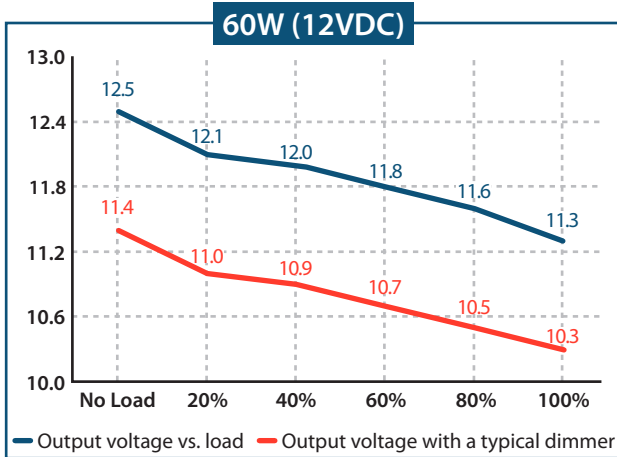

96W (12VDC)

96W 12VDC is not available in the M-Series.

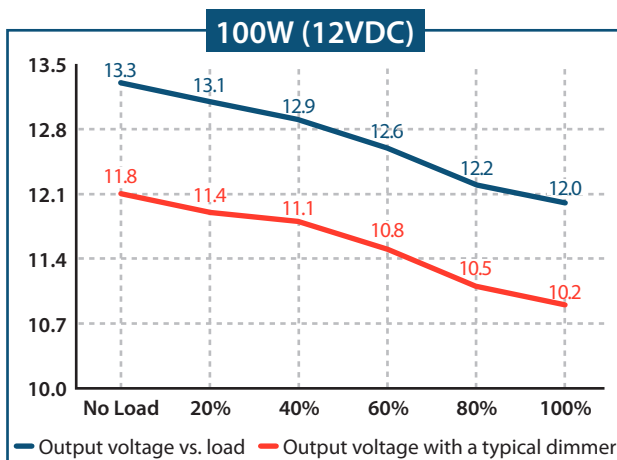
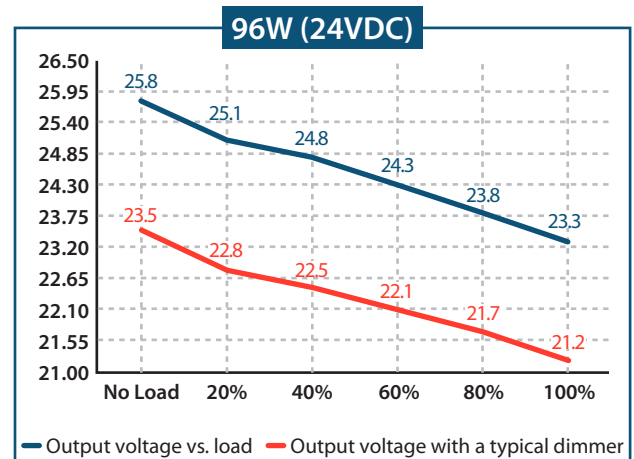

100W (24VDC)

100W 24VDC is not available in the M-Series.

OUTPUT vs LOAD

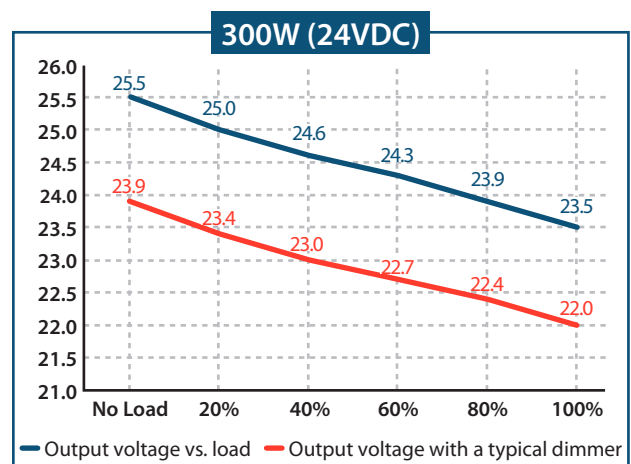
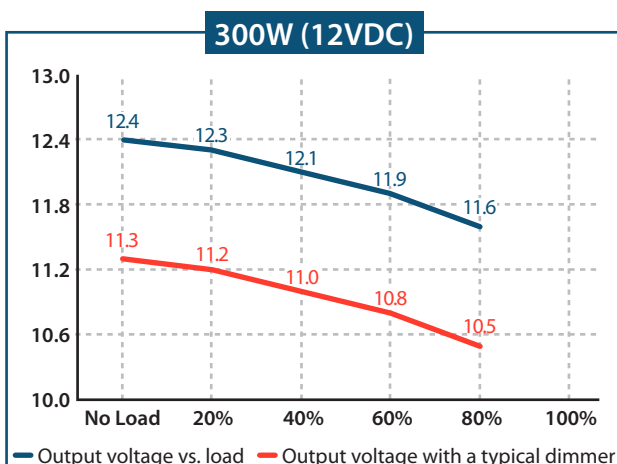
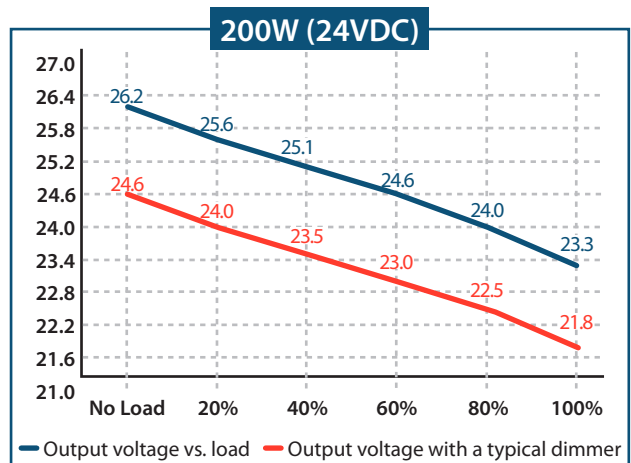
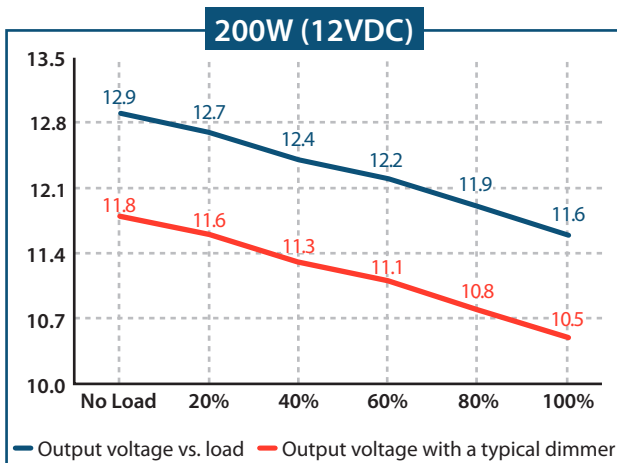
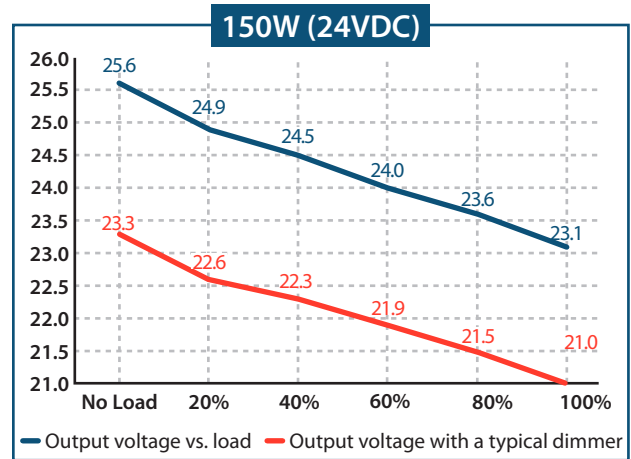
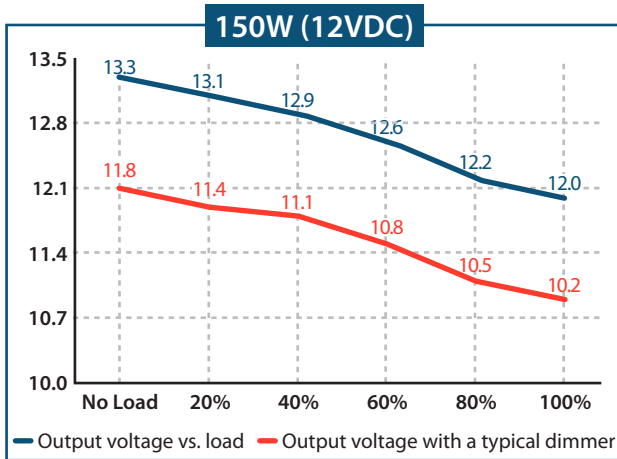

WIRING DIAGRAMS

